

**Инструкция по сборке**  
**Instructions for assembling furniture**  
**Instrukcja montażu mebli**

**Набор мебели для Collection Koleczja mebli**  
**общей комнаты**

**«TORINO»**

**Тумба RTV 1V2D1S**  
**Sideboard RTV 1V2D1S**  
**Szafka RTV 1V2D1S**

АН-064.07.00.00

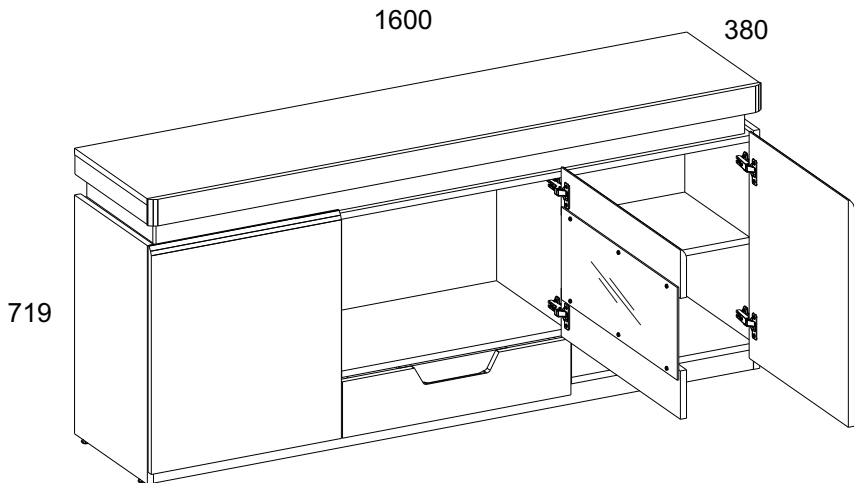

Дата изготовления  
Production date  
Data produkcji

Штамп ОТК  
Stamp of Quality Department  
Pieczęć Działu Jakości

**ИООО « АНРЭКС »**

Республика Беларусь, 224004  
г.Брест, ул. Катин Бор, 119  
тел/факс (+375162) 29-74-68



ЕАЭС №BY/112 11.01. TP025 018 05664  
от 05.08.2020  
по 04.08.2025

### **Инструкция по эксплуатации.**

Качество и комплектность изделия рекомендуется проверять в магазине при покупке в распакованном виде. Сборка изделия должна производиться в порядке, изложенном в настоящей инструкции. В процессе эксплуатации изделий необходимо периодически затягивать ослабленные винтовые соединения. В случае необходимости перемещения изделия по квартире перед его перестановкой, необходимо полностью освободить его от груза (матраца). Во избежание поломок имеющих опору передвижение производить приподнимая изделие над уровнем пола. Запрещён прямой контакт с водой. Удаление пыли с изделий следует производить слегка влажной мягкой салфеткой. Во избежание коробления деталей и изменения цвета изделия следует избегать установки мебели на прямых солнечных лучах.

При эксплуатации изделий набора **ЗАПРЕЩАЕТСЯ:**

- устанавливать мебель вблизи отопительных приборов и вплотную к сырým стенам и в помещениях с относительной влажностью более 70%;
- температура нагрева элементов мебели не должна превышать +40 °С.
- в процессе сборки и эксплуатации изделий набора становиться ногами на горизонтальные щиты и витрины;
- применять химические чистящие средства для уборки мебели;

#### **Гарантии изготовителя.**

1. Гарантийный срок эксплуатации изделия - 24 месяца со дня продажи магазином. В период гарантийного срока изготовитель гарантирует ремонт изделий или их замену, если потребителем не нарушены правила эксплуатации.
2. Претензии предъявляются потребителем непосредственно в торгующую организацию, в которой была приобретена мебель, предъявив настоящую "Инструкцию по сборке" и копию товарного чека.
3. Изделие **Тумба RTV 1V2D1S**, входящее в состав набора мебели для общей комнаты «**TORINO**», соответствует требованиям ГОСТ 16371-2014, ТР ТС 025/2012.
4. Срок службы мебели - 5 лет.
5. Предприятие-изготовитель оставляет за собой право вносить изменения в конструкцию изделия, не ухудшая его конструктивные и эксплуатационные характеристики.
6. Для сборки изделий рекомендуется привлекать квалифицированных специалистов.

#### **Запах.**

От новой мебели может исходить запах материалов, из которых она изготовлена. Запах может сохраняться в течение трёх недель с момента сборки. Для снижения интенсивности запаха рекомендуется:

- для мягкой мебели - пропылесосить изделие и проветрить помещение.

Повторять 3-4 раза в день.

- для корпусной мебели – протирать тканью, смоченной мягким моющим средством, вытирать чистой сухой тканью и проветривать помещение, предварительно открывая все двери и ящики изделия.

Повторять 3-4 раза в день.

**Важно!** Сохраните, пожалуйста, инструкцию в случае повторной сборки мебели или рекламации. В случае составления рекламации пользуйтесь, пожалуйста, обозначением из инструкции сборки.

**PL****Przy eksploatacji mebli zabrania się:**

- ustawiać meble w pobliżu grzewczych przyrządów i obok wilgotnych ścian, a także w pomieszczeniach ze względną wilgotnością więcej niż 70%;
- temperatura nagrzewania elementów mebli nie może przekraczać +40°C;
- w trakcie montażu i eksploatacji mebli stawać nogami na poziome panele i witryny;
- stosować chemiczne środki czyszczące do sprzątania mebli;
- nie należy narażać na kontakt z wodą.

**Gwarancje producenta.**

1. Gwarancyjny termin eksploatacji wyrobu - 24 miesiące z dnia sprzedaży. W okresie gwarancyjnego terminu producent gwarantuje naprawę wyrobów lub ich zamianę, jeżeli reguły eksploatacji nie zostały naruszone przez nabywcę.
2. Roszczenia są przekazywane przez nabywcę bezpośrednio do handlującej organizacji, w której były nabyte meble, tylko przy okazaniu danej "Instrukcji montażu" wraz z dokumentem zakupu.
3. Wyrób **Szafka RTV 1V2D1S**, wchodzące w zestaw mebli **"TORINO"**, odpowiada wymaganiom Norm Państwowych 16371-2014, TP TC 025/2012
4. Trwałość użytkowa mebli - 5 lat.
5. Firma-producent pozostawia za sobą prawo do wprowadzania zmian w konstrukcje wyrobów, nie pogarszając ich konstruktywne i eksploatacyjne charakterystyki.
6. Do montażu wyrobów zaleca się skorzystanie z pomocy wykwalifikowanych specjalistów.

**Zapach.**

Nowe meble mogą wydzielać zapach materiałów, z których są wykonane. Zapach może utrzymywać się do trzech tygodni od momentu montażu. Aby zmniejszyć intensywność zapachu, zaleca się:

- w przypadku mebli tapicerowanych - odkurzyć produkt i przewietrzyć pomieszczenie. Powtarzaj 3-4 razy dziennie.
- dla mebli szafkowych - przetrzyj ściereczką zwilżoną łagodnym detergentem, przetrzyj czystą, suchą ściereczką i przewietrz pomieszczenie, uprzednio otwierając wszystkie drzwi i szuflady produktu. Powtarzaj 3-4 razy dziennie.

**Ważne!** Proszę zachować instrukcję w razie ponownego montażu mebli lub reklamacji. Podczas składania reklamacji prosimy o korzystanie z oznaczeń z instrukcji.

**EN****Instruction manual.**

It's advised to check the quality and completeness of the product in the store when buying unpacked. Assembling of the product should be done the way it's described in this manual. While the product is in service loose screw connections should be periodically tightened. If it's necessary to move items around the apartment before moving you should release the product completely from the load (the mattress). To prevent damage to existing supports the product should be lifted before moving. Furniture should not be exposed to contact with water. Dusting the product should be done with a slightly damp soft cloth. To prevent warping of parts and discoloration of products do not install furniture in direct sunlight.

**While the product is in service it's PROHIBITED TO:**

- Install furniture near heating devices, close to the raw walls and in rooms with a relative humidity of more than 70%;
- heat elements of furniture to the temperature higher +40°C;
- step on the horizontal shields and windows during assembly and use of the products set;
- use chemical cleaners for cleaning furniture;

**Manufacturer's warranty.**

1. The warranty period of use of the product - 24 months from the date of sale. During the warranty period the manufacturer guarantees repair or replacement of products, if the user has not violated operating rules.
2. Claims should be made by the consumer directly to the trading organization, in which furniture was purchased, presenting the "Instruction manual" and a copy of the sales receipt.
3. The product **Sideboard RTV 1V2D1S**, which are part of a set of **"TORINO"**, meets the requirements of GOST 16371-2014, TR TS 025/2012.
4. The lifetime of furniture - 5 years.
5. The manufacturer reserves the right to make changes in product design, without compromising its design and application requirements.
6. To assemble the products it's recommended to attract qualified personnel.

**Smell.**

New furniture may emit the smell of the materials from which it is made. The smell can persist for up to three weeks from the time of assembly. To reduce odor intensity, it is recommended:

- for upholstered furniture - vacuum the product and ventilate the room. Repeat 3-4 times a day.
- for cabinet furniture - wipe with a cloth dampened in a mild detergent, wipe with a clean, dry cloth and ventilate the room, previously opening all doors and drawers of the product. Repeat 3-4 times a day.







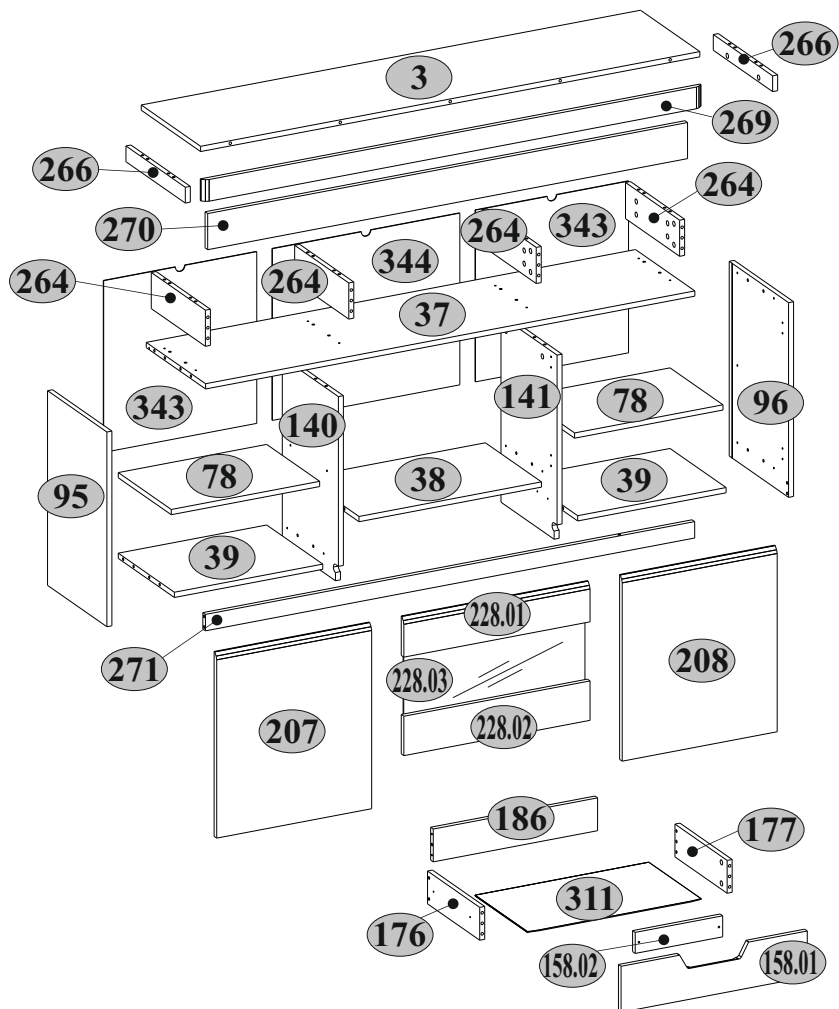





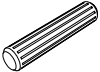

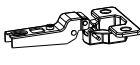





**It is important!** Keep the instruction in case of reassembly of furniture or complaint. When making a claim use the notation from the instruction.

№ п/п	Длина мм	Ширина мм	Толщина мм	Кол-во шт.	№ пачки
3	1598	364	16	1	2/4
37	1566	364	16	1	2/4
38	584	344	16	1	4/4
39	475	344	16	2	3/4
78	475	325	16	2	4/4
95	593	364	16	1	3/4
96	593	364	16	1	3/4
140	567	344	16	1	4/4
141	567	344	16	1	4/4
158.01	596	140	16	1	3/4
158.02	280	64	16	1	4/4
176	320	100	16	1	3/4
177	320	100	16	1	3/4
186	526	100	16	1	3/4

№ п/п	Длина мм	Ширина мм	Толщина мм	Кол-во шт.	№ пачки
207	563	496	16	1	1/4
208	563	496	16	1	1/4
228.01	596	120	16	1	1/4
228.02	596	120	16	1	1/4
228.03	580	230	4	1	1/4
264	332	110	16	4	2/4
266	364	48	16	2	3/4
269	1600	66	16	1	2/4
270	1536	110	16	1	2/4
271	1566	50	16	1	2/4
311	556	325	2,5	1	3/4
343	523	490	2,5	2	1/4
344	523	600	2,5	1	1/4



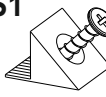
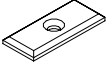

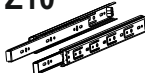
<b>A1</b>  7x34 57	<b>A2</b>  57	<b>B5</b>  10x50 2	<b>C1</b>  8x35 54
<b>D1</b>  6	<b>E1</b>  4	<b>E4</b>  2	<b>I</b>  S4 1
<b>N11</b>  8	<b>N19</b>  8	<b>P5</b>  8	<b>Q</b>  7x1,5 6
<b>Q6</b>  6	<b>R3</b>  3x20 25	<b>R32</b>  4,0x27 2	<b>R23</b>  6,3x13 12
<b>R24</b>  7x50 4	<b>R27</b>  5,0x13 10	<b>R45</b>  4x16 6	<b>R102</b>  3,5x16 16
<b>S1</b>  12	<b>S3</b>  8	<b>S5</b>  Ø18 12	<b>U</b>  90x35x15 2
<b>Z10</b>  300 1			

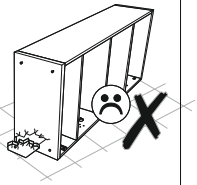
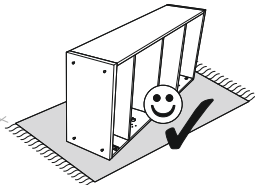
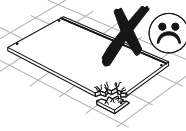
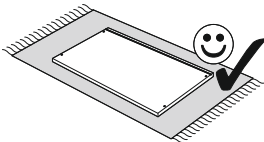
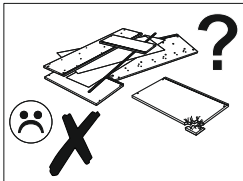
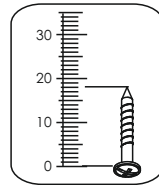
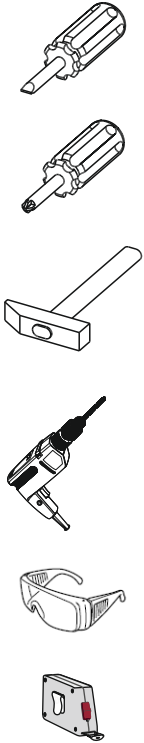
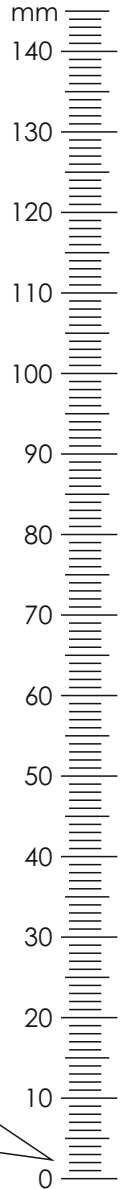

1

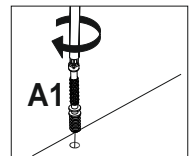
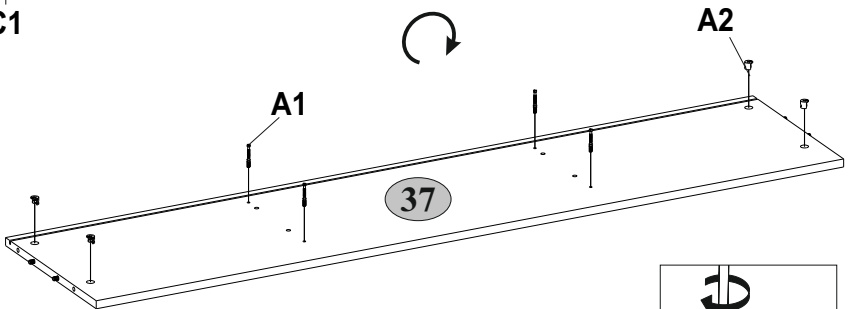
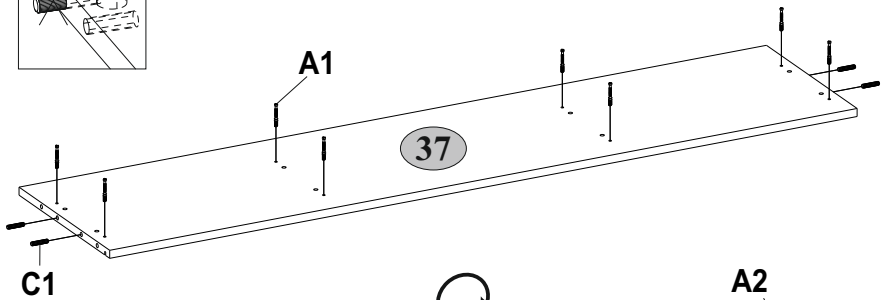
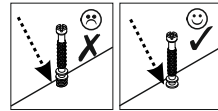
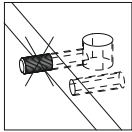
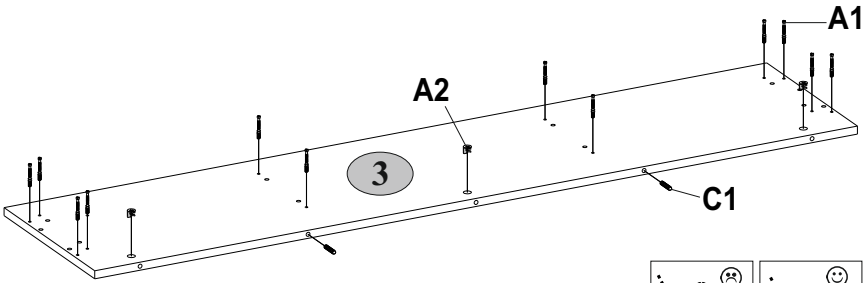
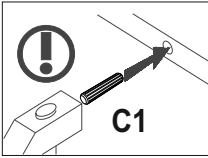
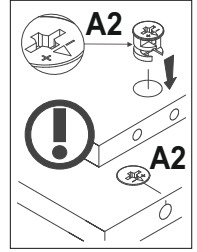
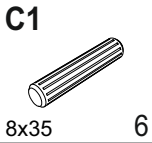
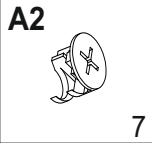

2

A1



7x34

D1

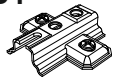

8

N11

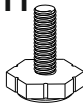

4

N19



4

P5



4

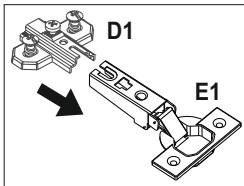

R23







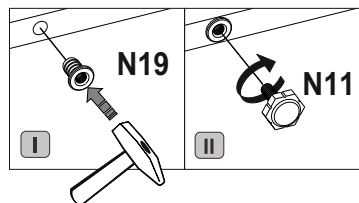
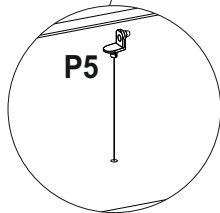
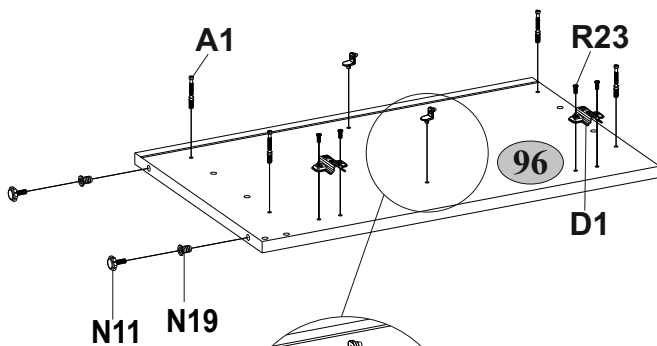
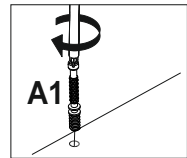
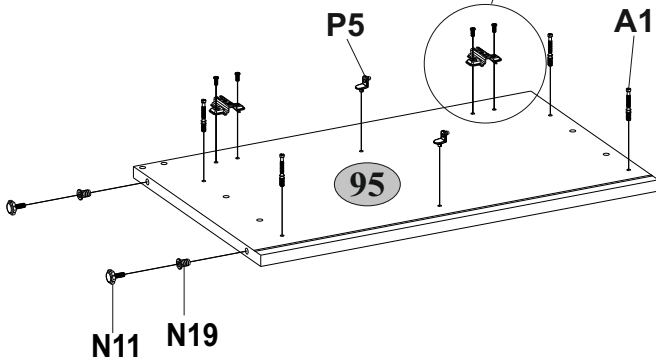
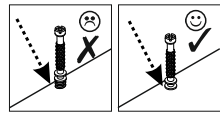
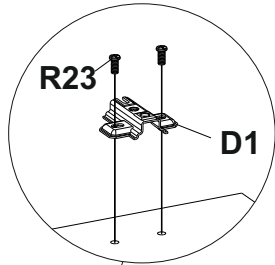

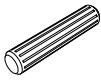
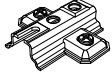

6,3x13

8



3

<b>A1</b>  7x34 8	<b>A2</b>  4	<b>C1</b>  8x35 4	<b>D1</b>  2	<b>N11</b>  4
<b>N19</b>  4	<b>P5</b>  4	<b>R23</b>  6,3x13 4	<b>R27</b>  5,0x13 6	<b>Z10</b>  300 1

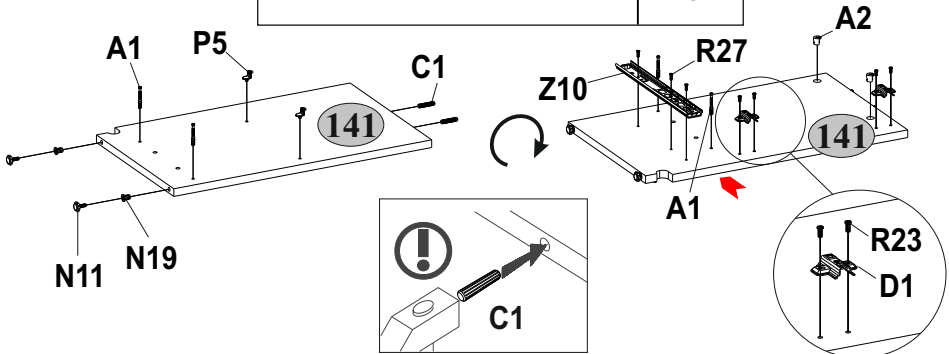
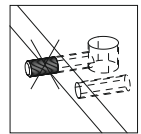
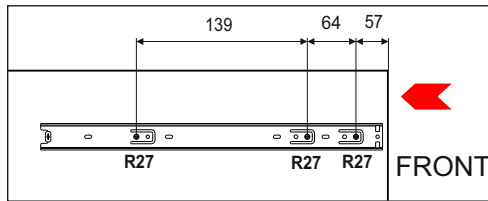
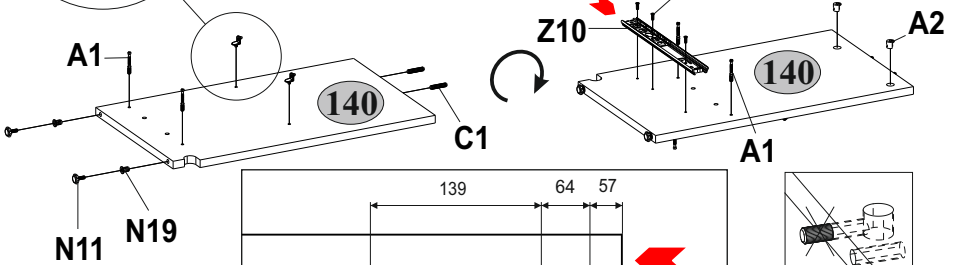
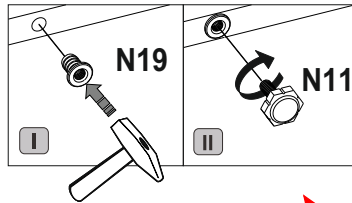
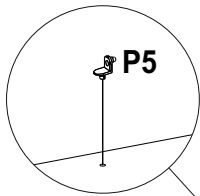
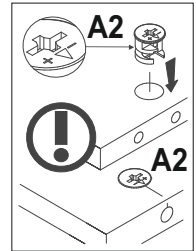
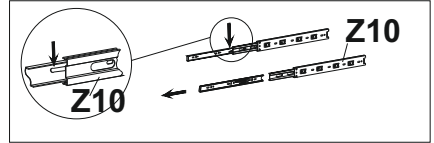
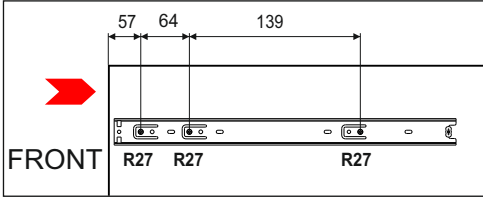



4

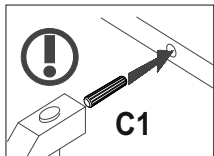
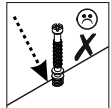
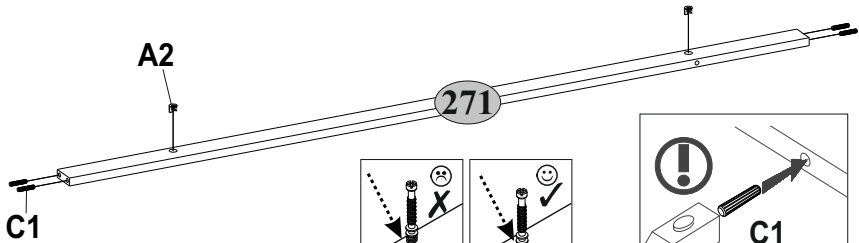
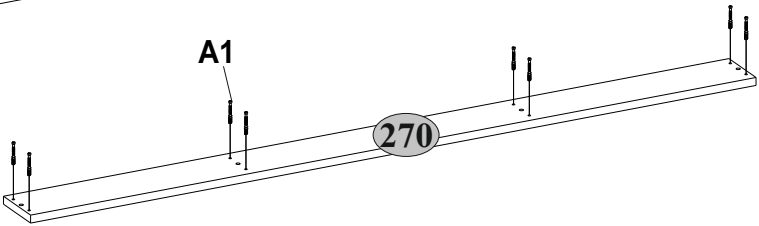
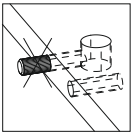
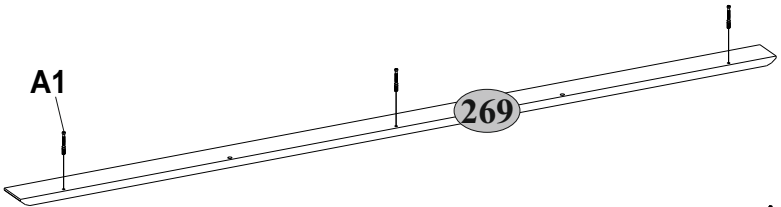
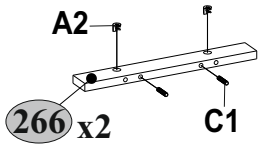
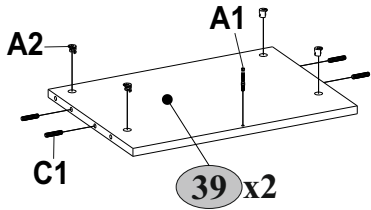
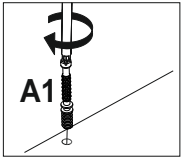
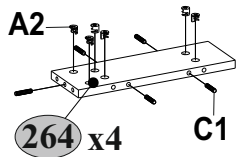
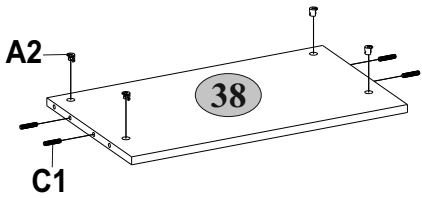
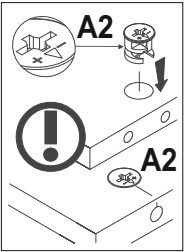
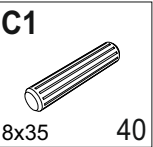
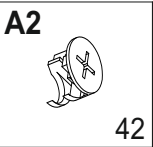
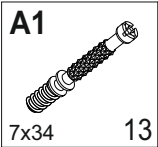

5

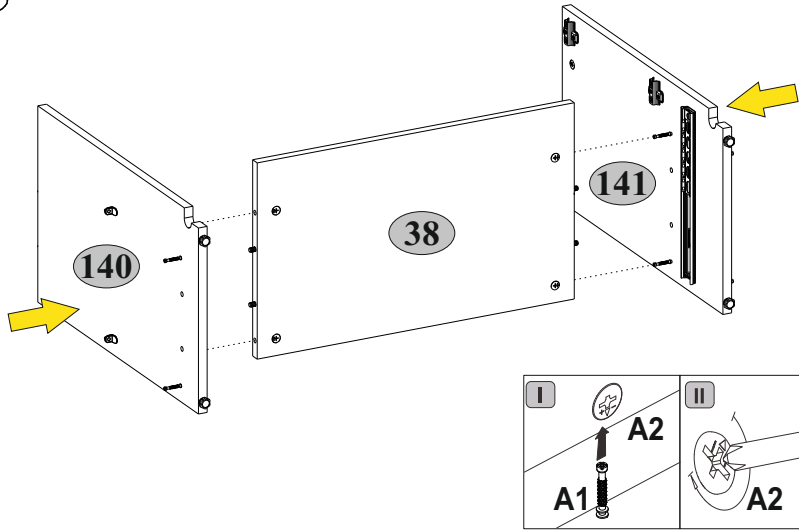

6

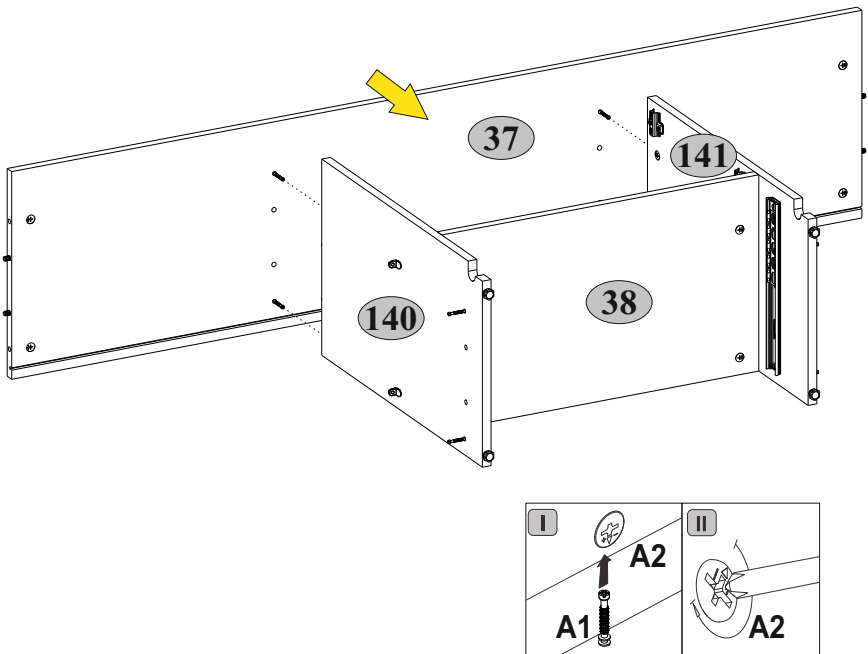

7

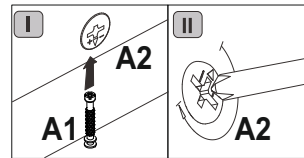
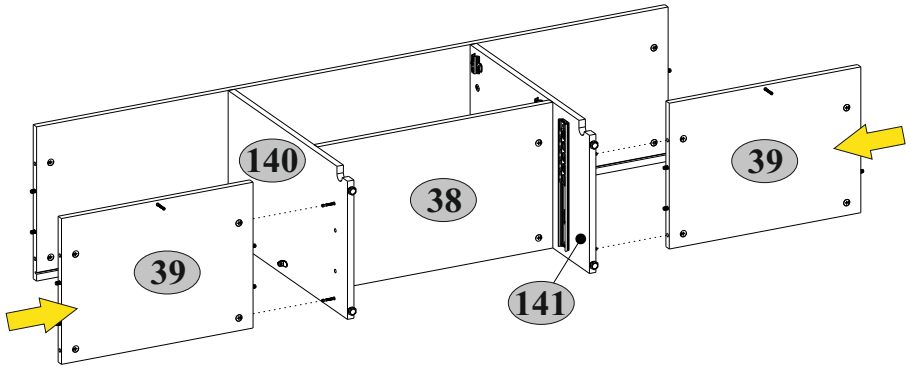

8

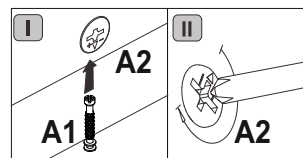
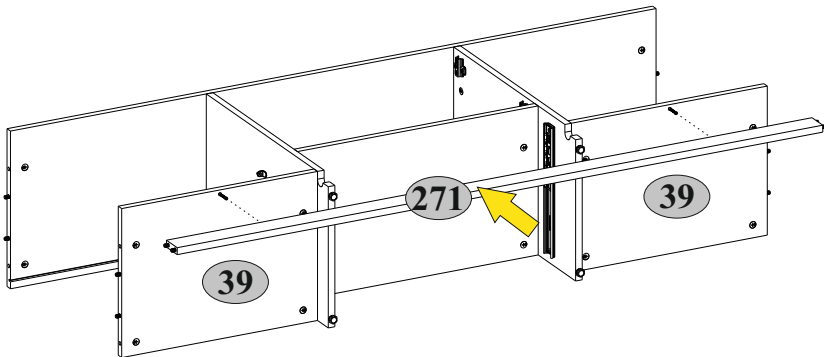

9

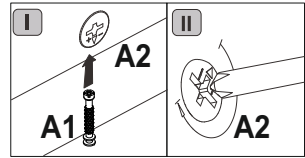
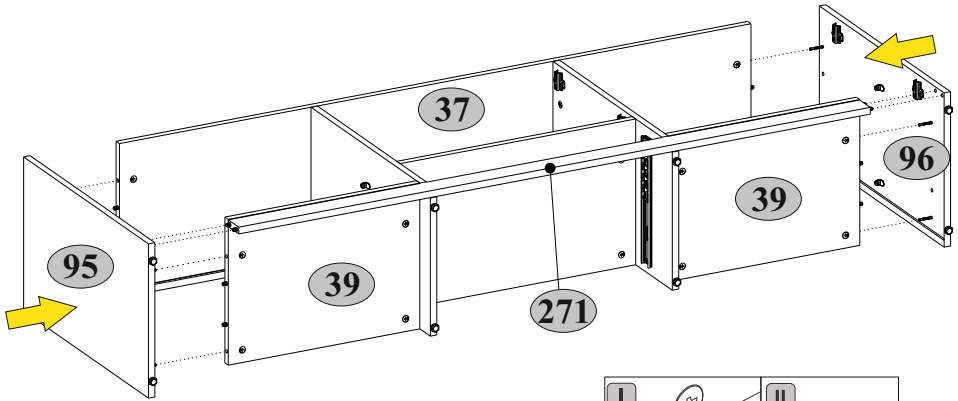

10

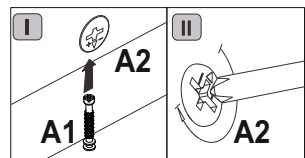
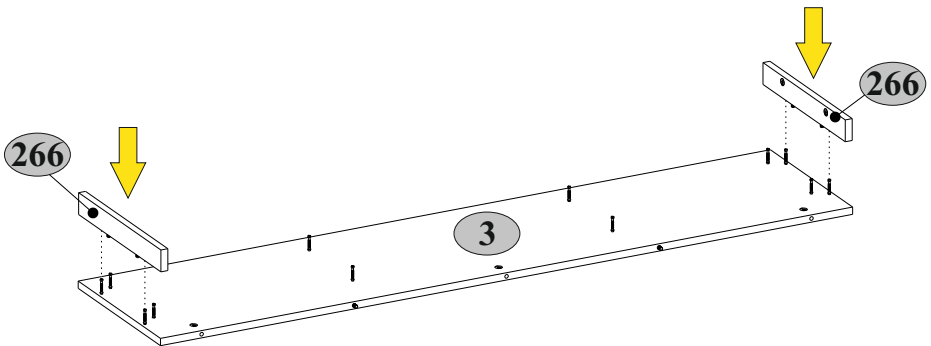

11

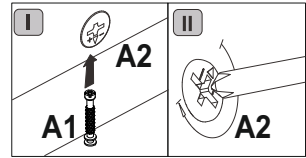
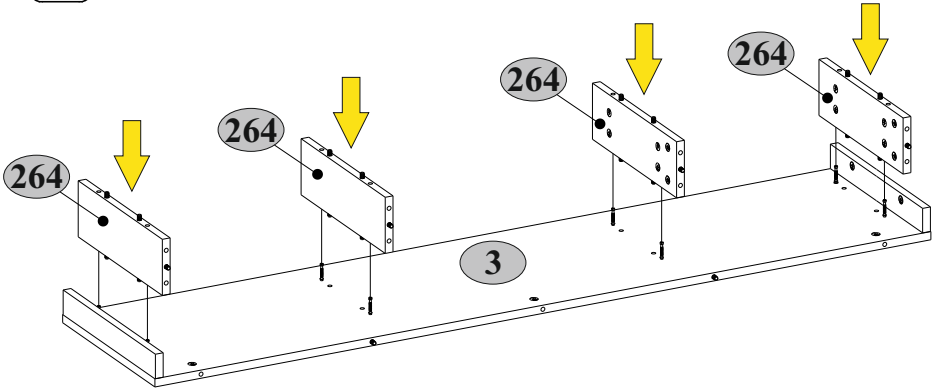

12

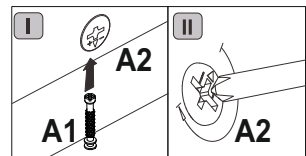
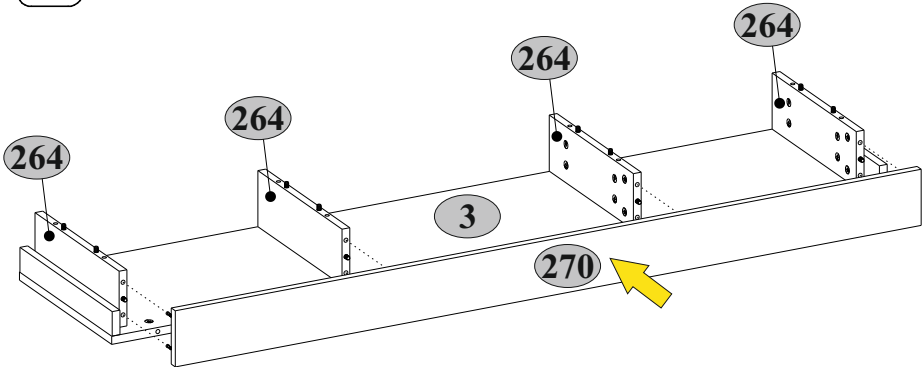

13

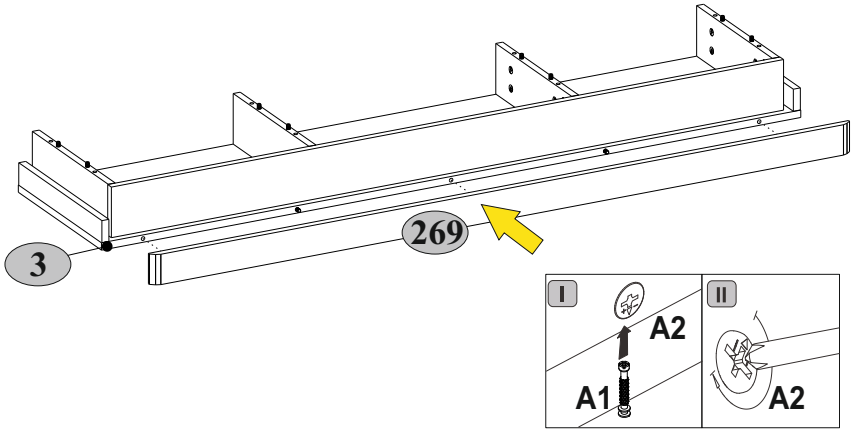

14

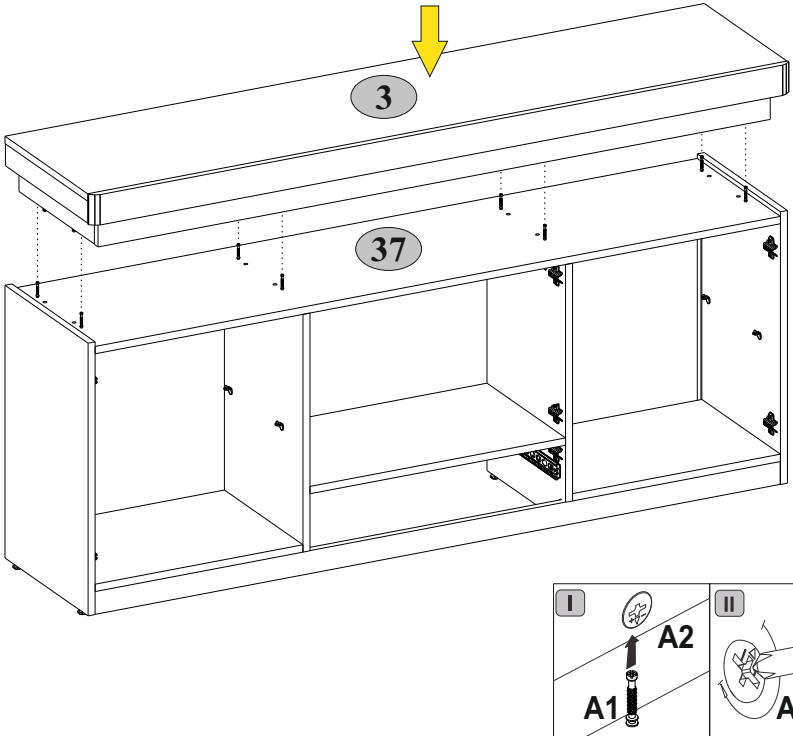

15

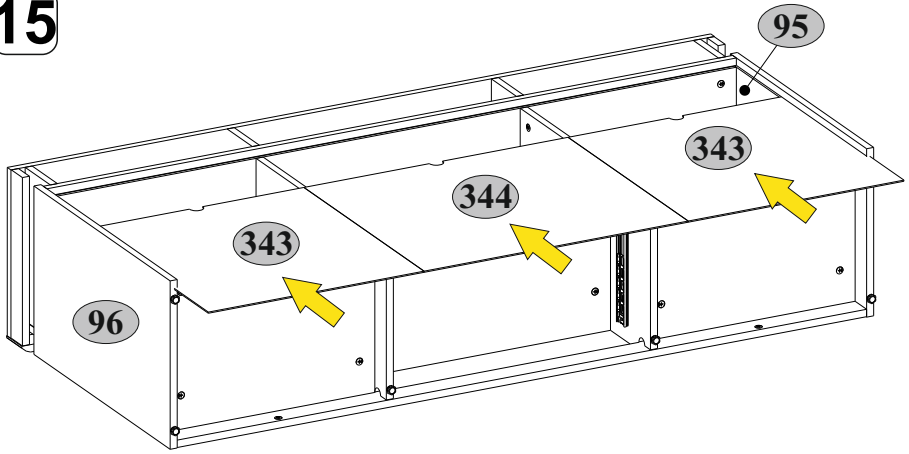

16

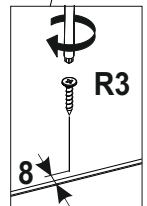
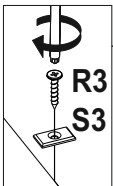
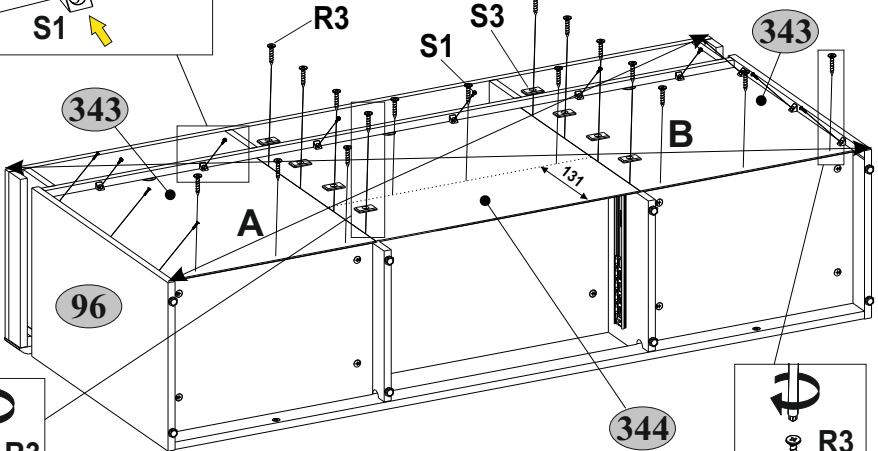
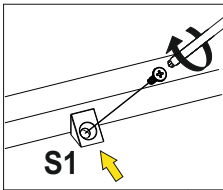
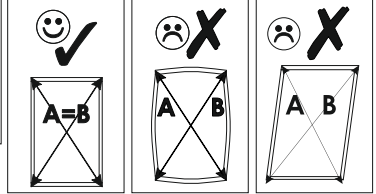
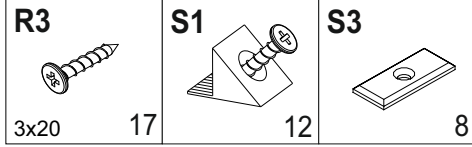

17

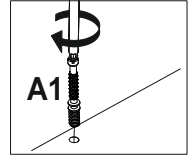
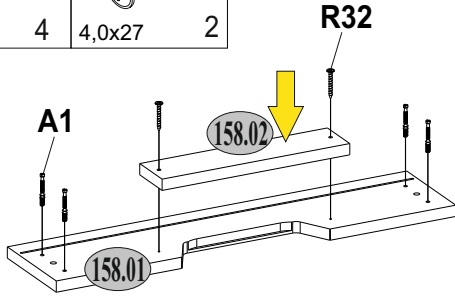
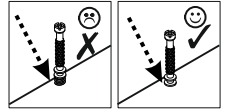
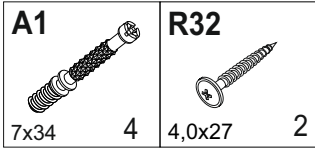

18

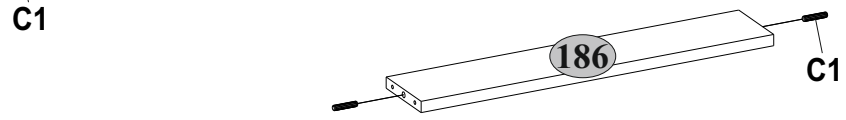
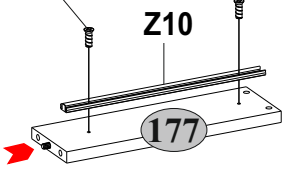
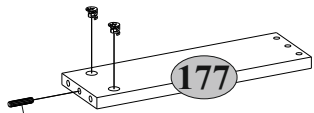
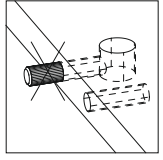
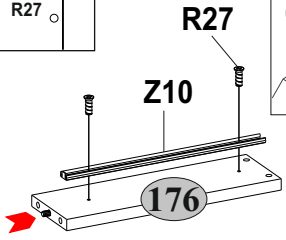
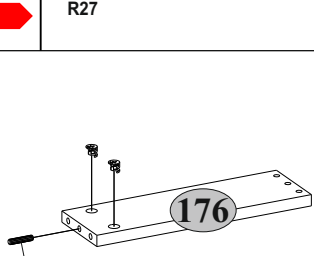
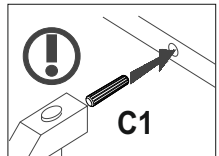
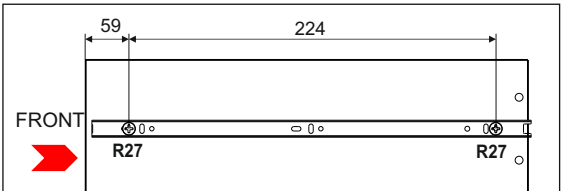
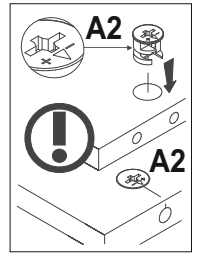
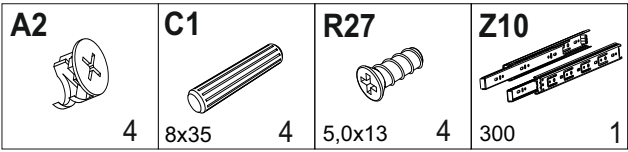



19

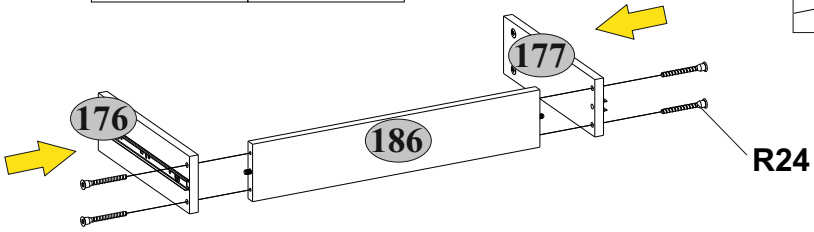
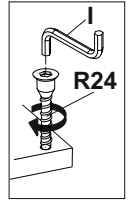
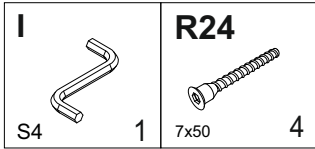

20

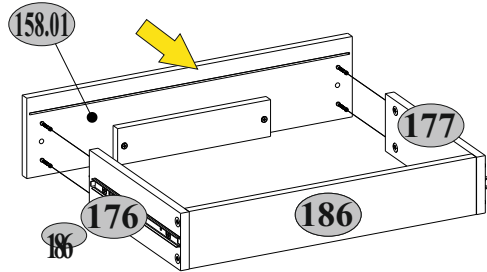
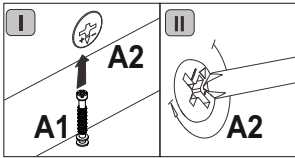

21

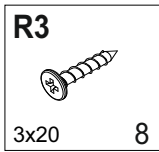

II

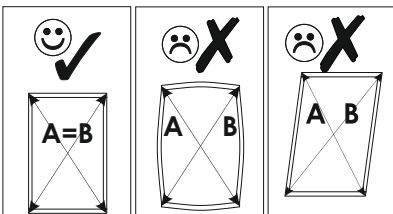
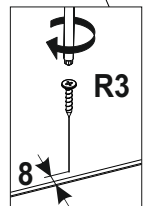
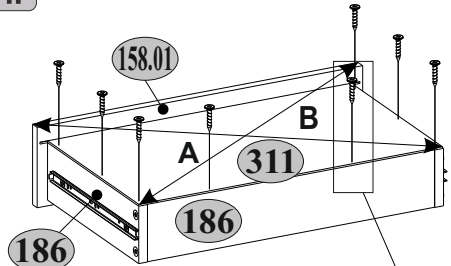
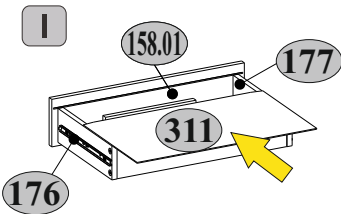

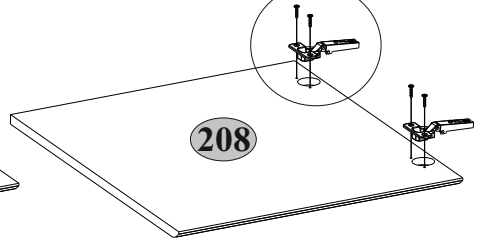
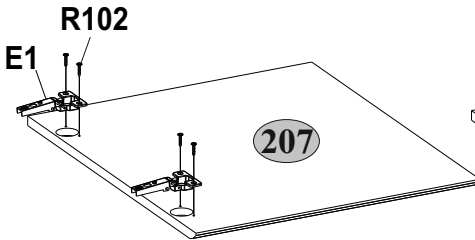
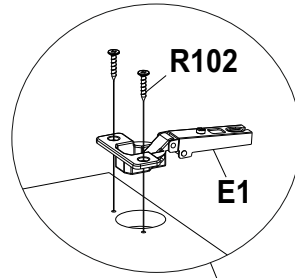
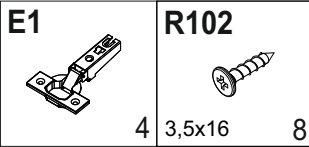
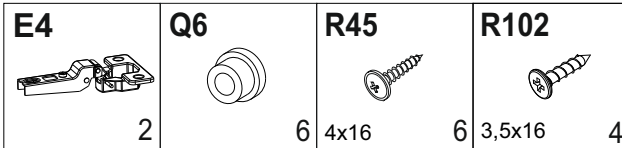
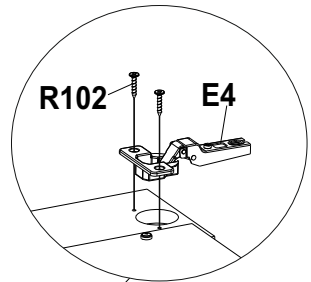
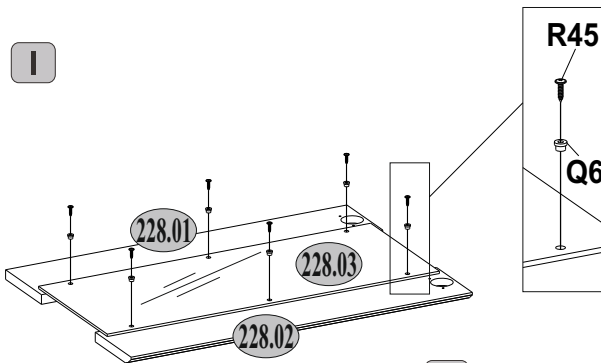
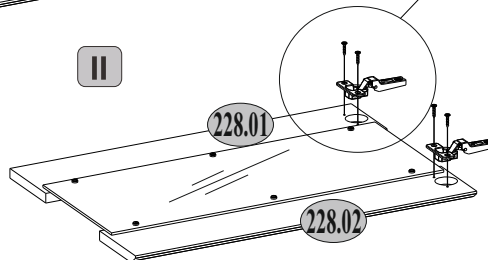
**22****23****I****II**

24

B5

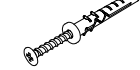

10x50

2

Q



7x1,5

6

R102



3,5x16

4

S5



Ø18

12

U



90x35x15

2

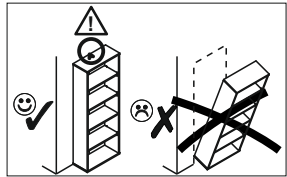
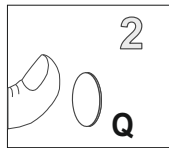
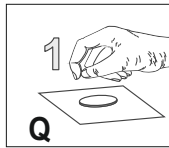
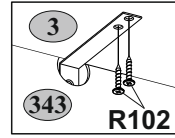
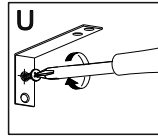
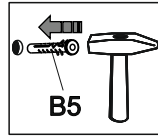
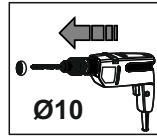
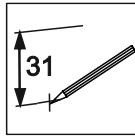
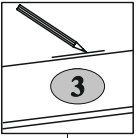

max. 15 kg  
 max. 5 kg

